

Canale attrezzato

Canali attrezzati

Codice: 3024 880



DETTAGLI

Bordo Installazione

Sottotop

Materiale

Acciaio inox AISI 304

Finitura

Spazzolato Foster

Texture

Spazzolatura in linea

Base

60 cm

Dimensioni esterne

438 x 170 mm

Dimensioni interne

422 x 122 mm

Larghezza

43,8 cm

Lunghezza

3 unità - Standard

Foro incasso

Vedi scheda tecnica

Dotazioni standard

Viti di fissaggio, piletta, imballo in scatola

Piletta

Piletta 1¼"

Chiave di lettura per gli accessori

Le lunghezze dei canali e degli accessori sono indicate in "unità", per la composizione la somma delle "unità" degli accessori deve corrispondere alla lunghezza in "unità" del canale.

DATI TECNICI

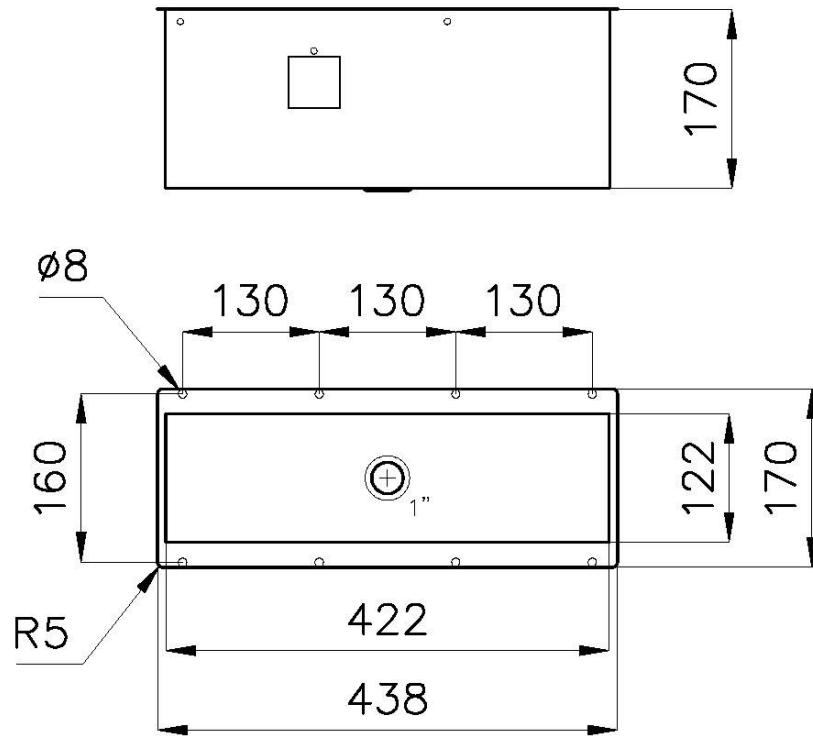

Sottotop/Undermount

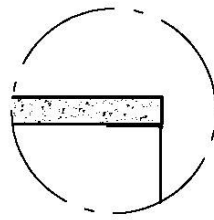

B-B:
Dettaglio installazione
Installation detail

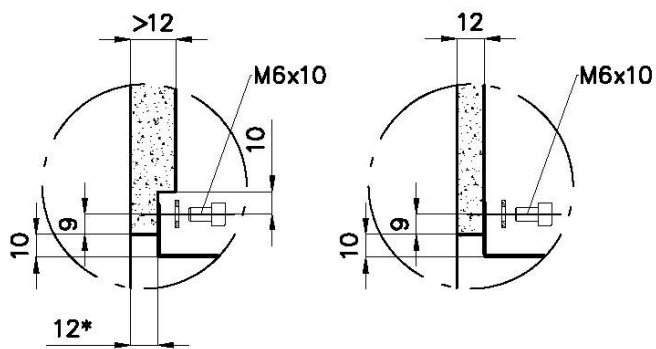

A-A:
Dettaglio installazione positive reveal e sistema di fissaggio
Installation detail with positive reveal and fixing system

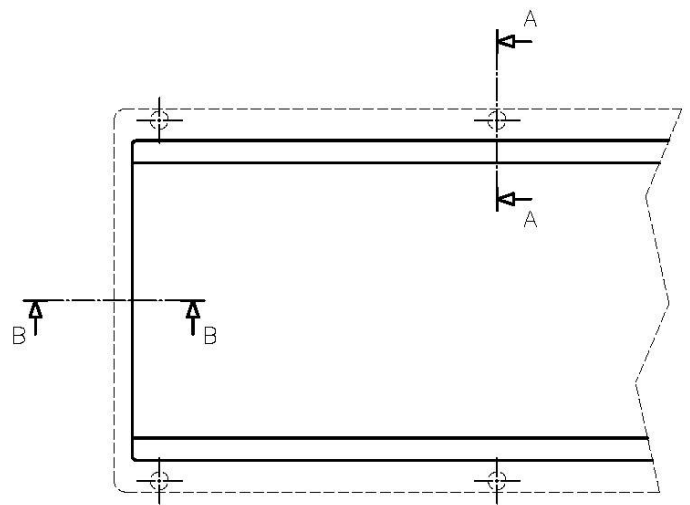

*spessore consigliato per un abbinamento perfetto con gli accessori
*recommended thickness for a perfect match with the accessories

Dimensioni per foratura top
Cut out size

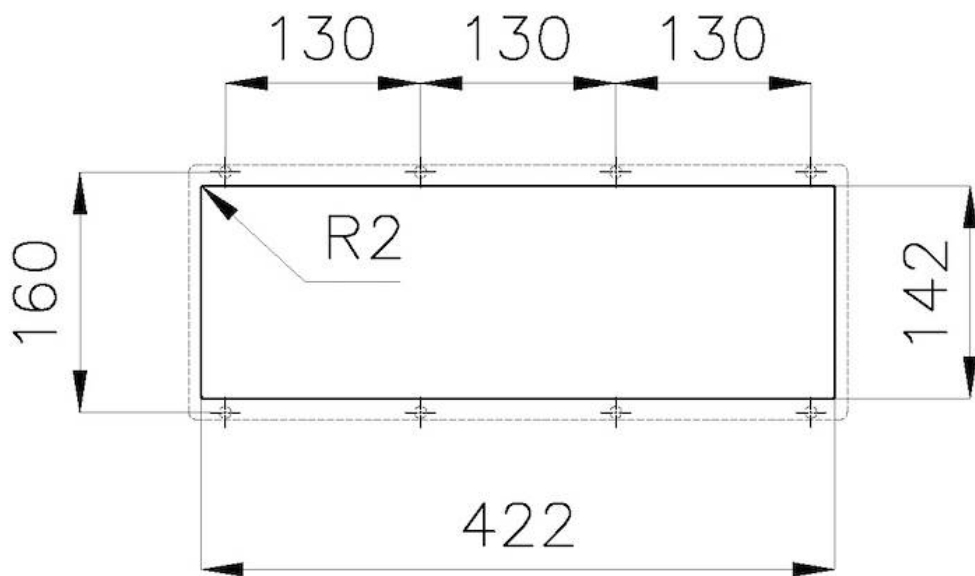

GALLERIA FOTOGRAFICA

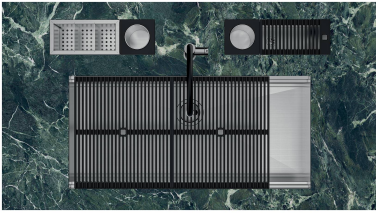

ACCESSORI OPZIONALI



Gocciolatoio Black
8100 058



Kit "A"
8100 703



Kit "B"
8100 700



Kit "C"
8100 701



Kit "D"
8100 704



Kit "E"
8100 705



Kit "F"
8100 706



Kit "G"
8100 710



Kit "H"
8100 702



Kit "N"
8100 714



Portacoltelli inox
8100 712



Portapiatti inox
1773 100



Portaprese inox
8000 020



Vaschetta forata inox
8151 003